

ASSEMBLY INSTRUCTIONS

4ft/4ft6 Small Double/Double Chesterfield Ottoman Storage Bed

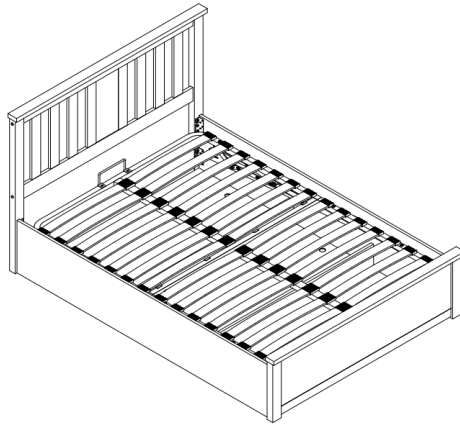









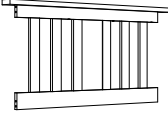
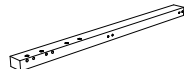
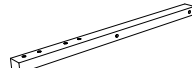

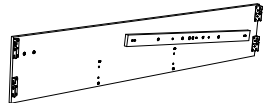
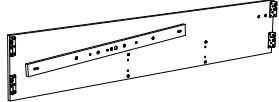
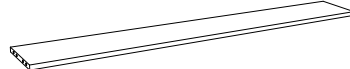
Please read the instructions carefully before assembly or use to ensure safe and satisfactory use of this product.



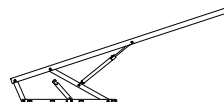

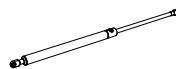
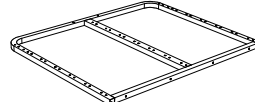
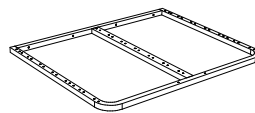





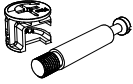

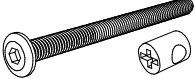

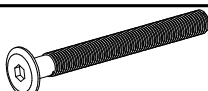

Please note:

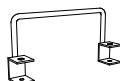
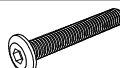
1. This product takes approximately 90 minutes to assemble (2 people).
2. This product fully assembled is heavy; it should be assembled as near as possible to the desired point of use.
3. Please do not drag the bed frame, always lift and reposition with 2 people to avoid personal injury as well as damage to the product.
4. Please do not discard any of the packaging until you have checked that you have all the parts and the pack of fittings.
5. DO NOT use any power tools as this may damage the frame and will invalidate any claim.
6. Periodically check all screws and fixings to ensure they are secure.
7. You will require a screwdriver and a small mallet (not provided).
8. Please do not jump on this bed frame.
9. The fittings pack contains small parts, which should be kept away from children.

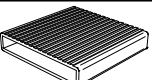
We hope you are delighted with your purchase, however if you have any further queries or concerns, or in the unlikely event that this product has missing or damaged parts, please contact our team with supporting images wherever possible, and keep hold of all original packaging. Please do not contact your courier for any queries regarding this product.

PART LIST			
PART	DESCRIPTION	BOX	QTY
1	Headboard Frame 	1/5	1
2	Left Wooden Post 	2/5	1
3	Right Wooden Post 	2/5	1
4	Footboard Frame 	1/5	1
5	Side Rail - Left 	4/5	1
6	Side Rail - Right 	4/5	1
7	Back Storage Panel 	2/5	1
8	Small Base Panel 	1/5	1
9	Large Base Panel 	1/5	3
10	Center Storage Panel 	2/5	1
11	Left Hydraulic Base Support 	5/5	1
12	Right Hydraulic Base Support 	5/5	1
13	Hydraulic Pump 	5/5	2
14	Back Bed Base (1 x Hole Mounting) 	3/5	1
15	Front Bed Base (2 x Hole Mounting) 	3/5	1
16	Wood Slat 	3/5	28

HARDWARE LIST (Found in box 3)

PART	DESCRIPTION		BOX	QTY
A	Mini Fix		3/5	12
B	M8 x 30mm Wood Dowel		3/5	16
C	ML-CB (Metal Corner Support)		3/5	2
D	M6 x 90mm JCBC Bolt + Barrel Nut		3/5	4
E	M8 x 25mm JCBC Bolt		3/5	16
F	M8 x 15mm JCBC Bolt		3/5	8
G	M8 x 20mm JBCB Bolt		3/5	10
H	M8 x 75mm JCBC Bolt		3/5	4
I	M8 Flat Washer		3/5	4
J	Base Nut		3/5	4
K	Base Handle		3/5	2
L	M6 x 40mm JCBC Bolt		3/5	4
M	M8 x 45mm RH Bolt c/w Hex Nut, Spring & Flat Washer		3/5	6
N	Single End Plastic Cap		3/5	28
O	Double End Plastic Cap		3/5	14
P	Wood Button		3/5	4
Q	M6 Allen Key		3/3	1
R	M8 Allen Key		3/3	1
S	M12.8 Spanner		3/3	1
T	M14 Spanner		3/3	1

** You will also need a screw driver and small mallet (not provided).

Step 1: Attach the headboard frame (1) and back storage panel (7) to the left wooden post (2) and right wooden post (3). Secure the headboard frame using hardware parts B, D and P, then secure the back storage panel with hardware parts A and B.

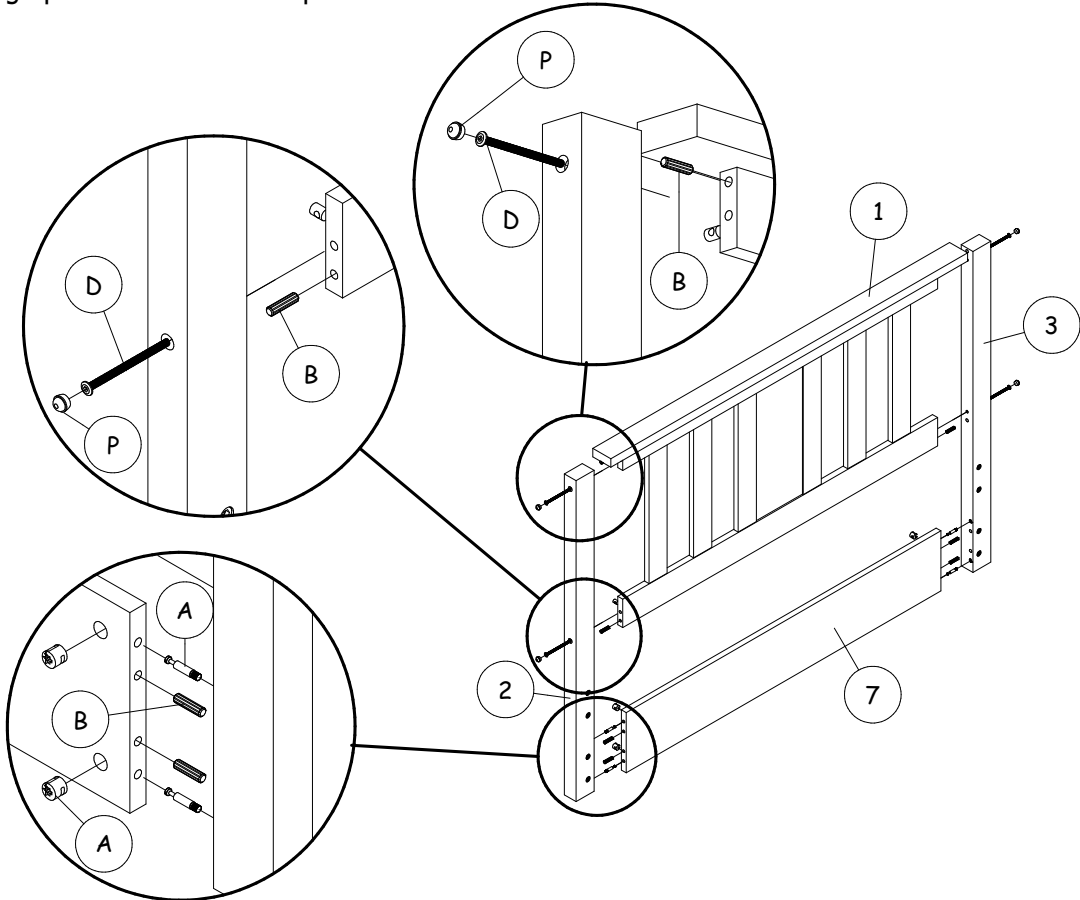

Step 2: Join together the left side rail (5) and right side rail (6) with the centre storage panels (10) using hardware parts A and B.

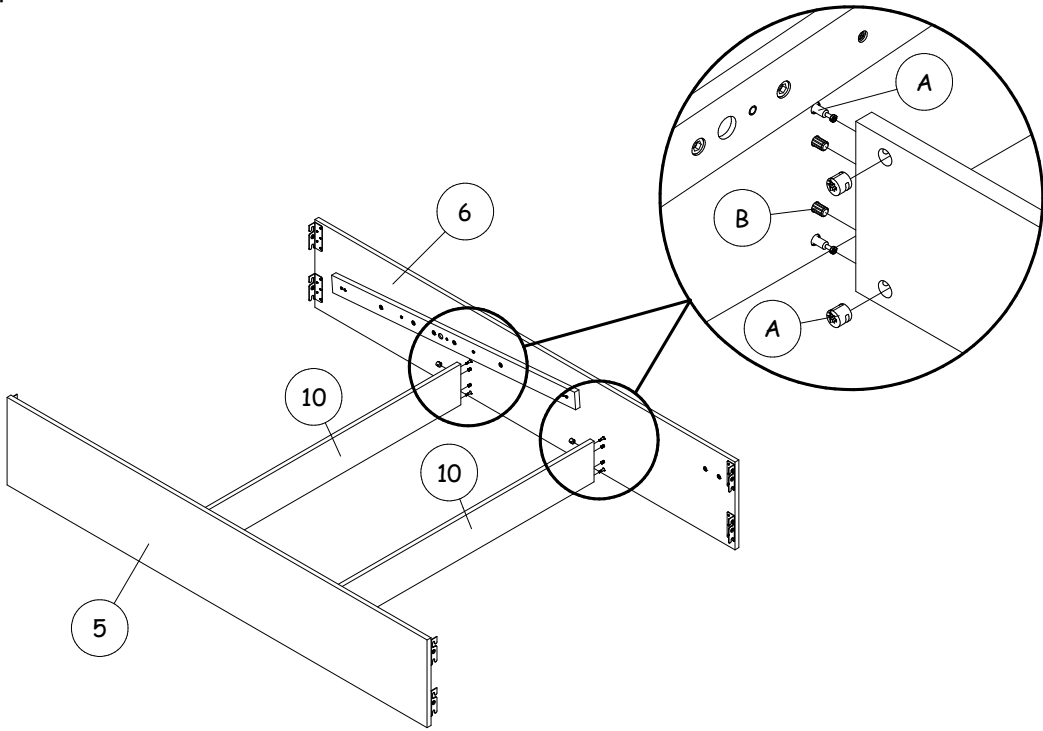

Step 3: Attach the headboard frame (1) and footboard (4) to the side rails using hardware part E.

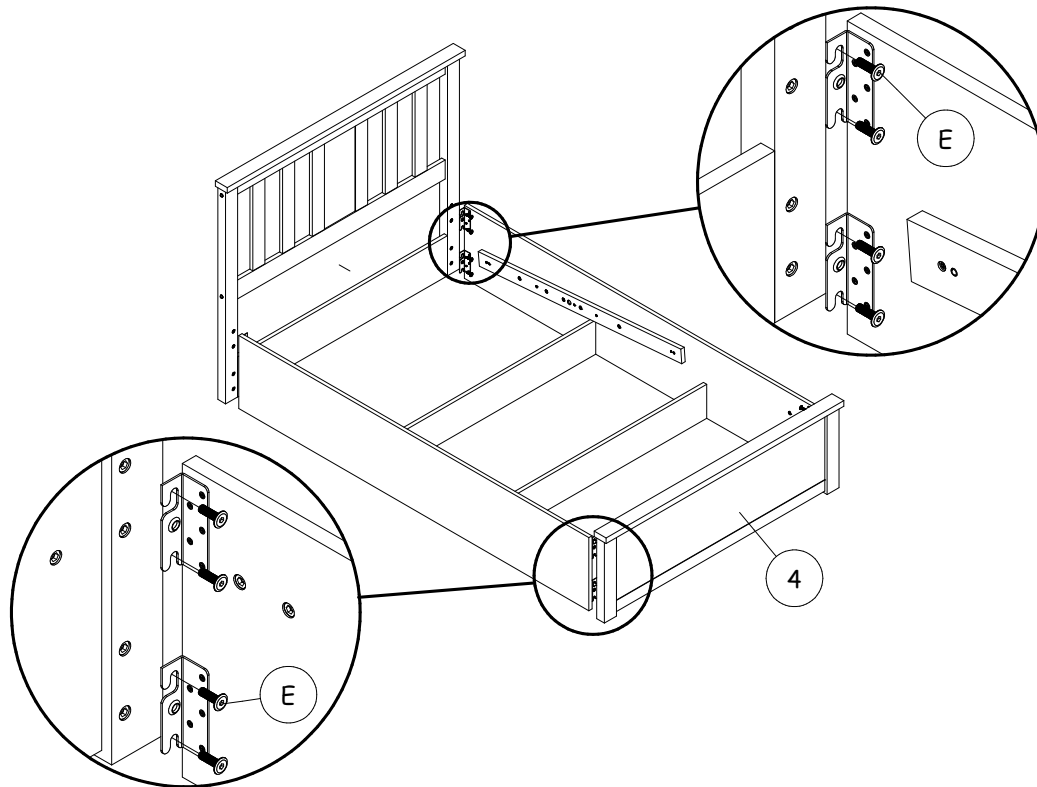

Step 4: Attach hardware part C using hardware part F.

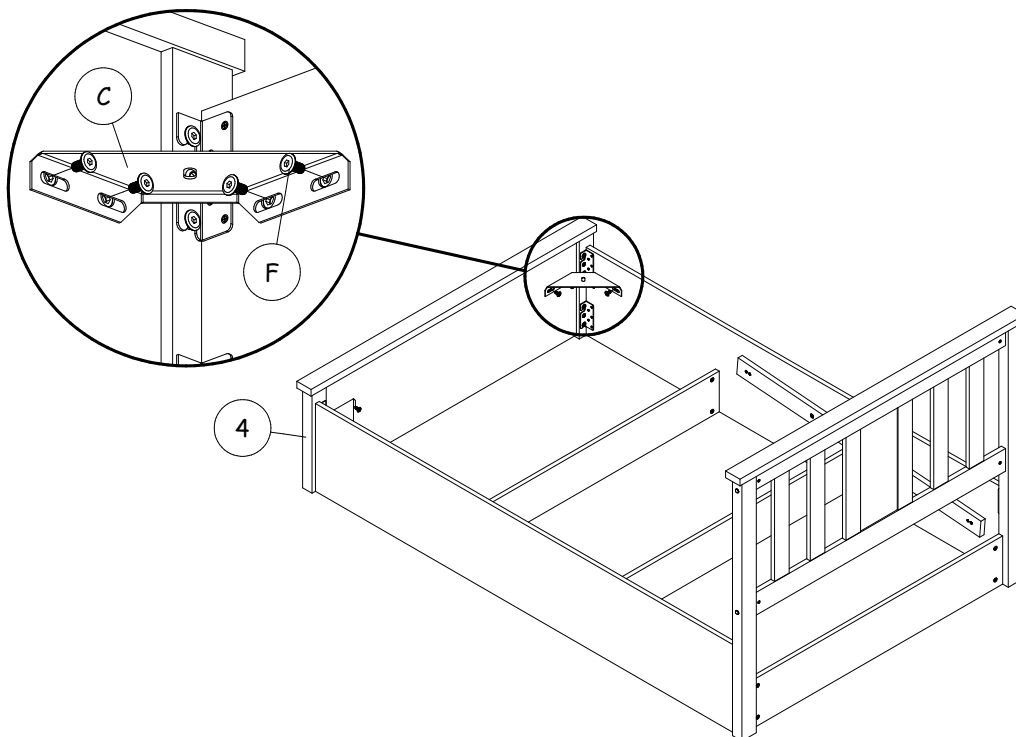

Step 5: Attach the hydraulic pumps (13) to each hydraulic base support (11,12) as shown in diagram 5.1. Next, fix the left & right hydraulic support to the both side rails. Then, fix bolts G first as shown in diagram 5.2 and do not tighten yet. Finally, fix all bolts and tighten as shown in diagram 5.3.

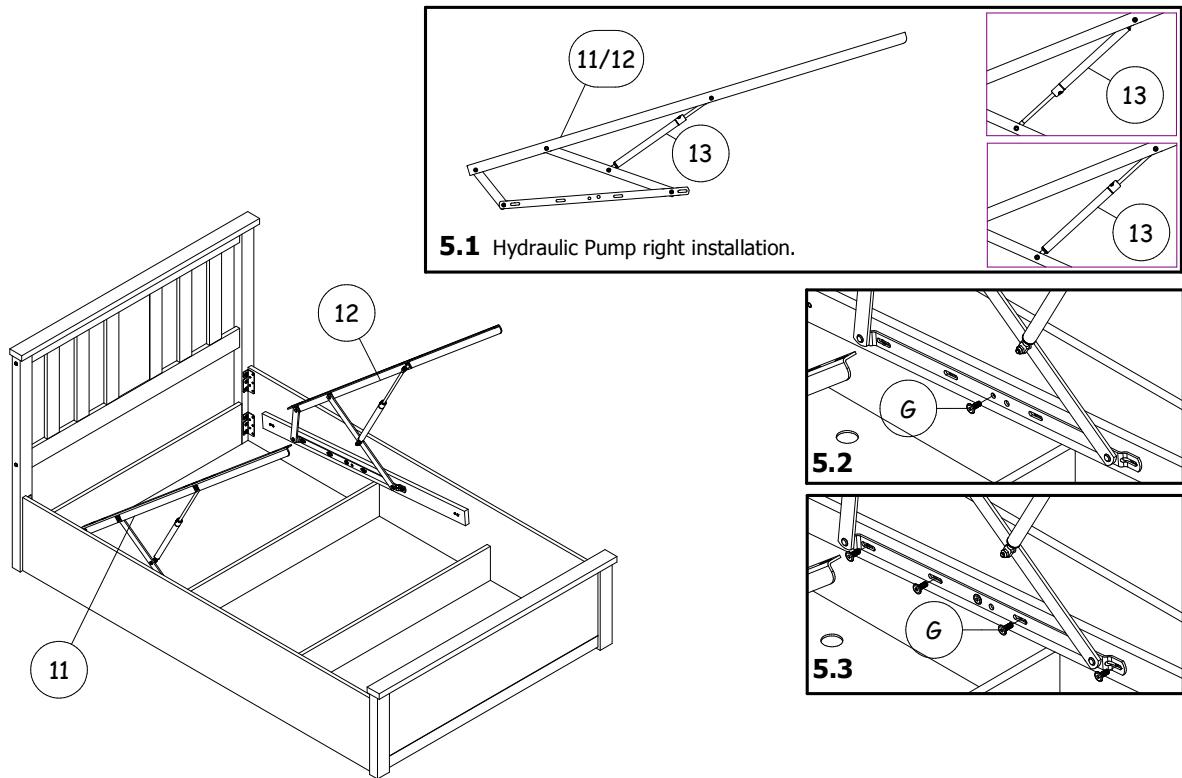

Step 6: Assemble front (15) & back (14) frame bed base with hardware part H, I, J. After that fix base handles K to the bed base with bolts L as shown.

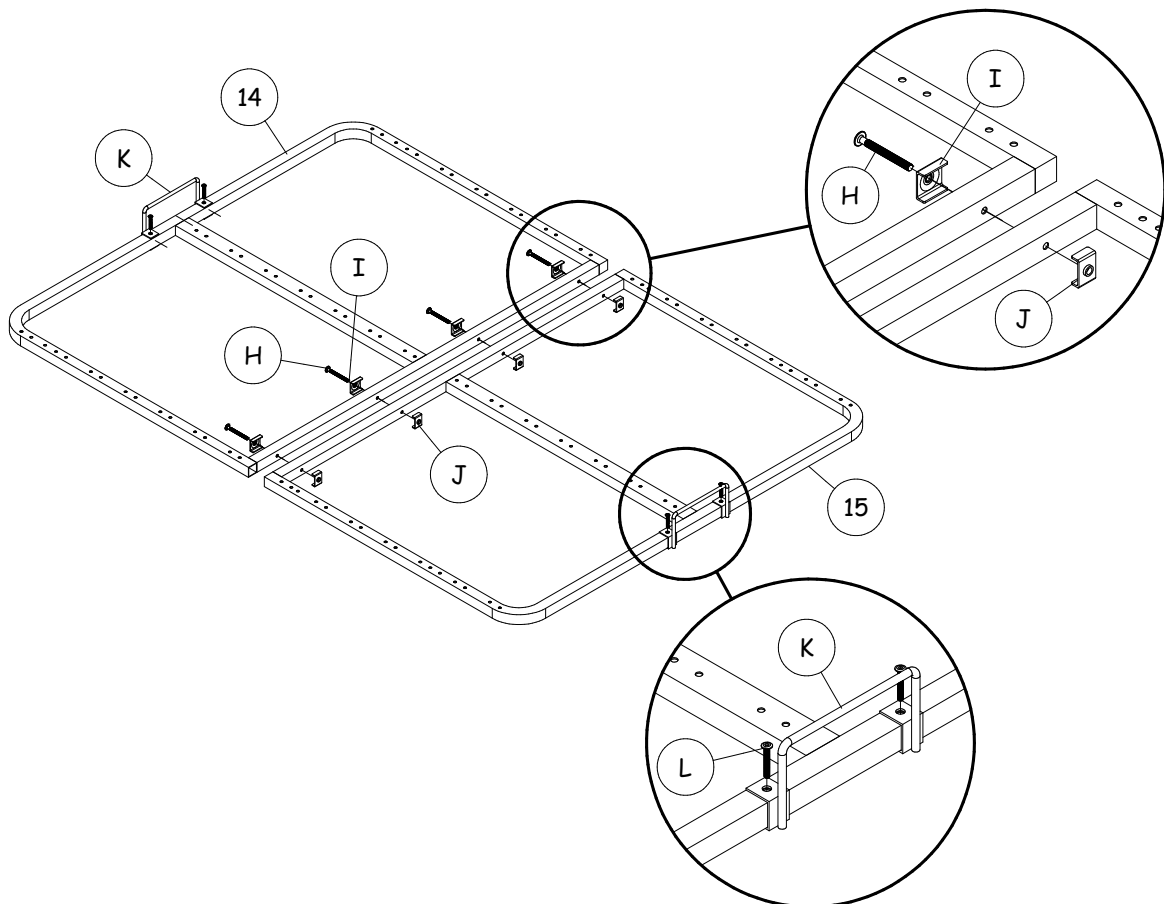

Step 7: Insert the slats (16) to hardware parts N and O then press into the base making sure they are secure.

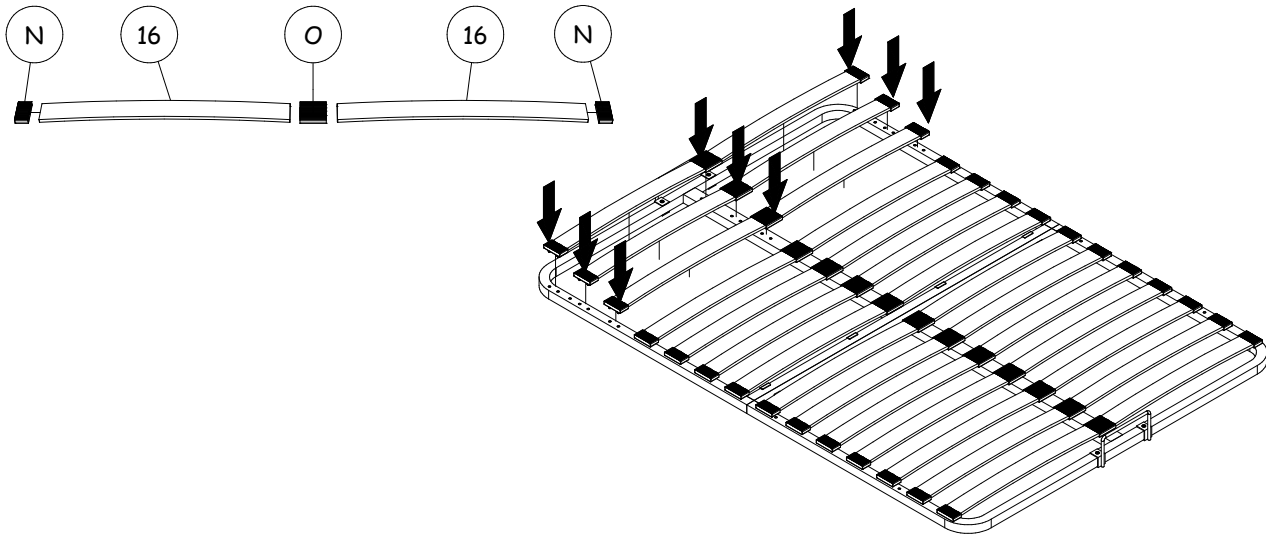

Step 8: Insert the small base panel (8) and large base panels (9).

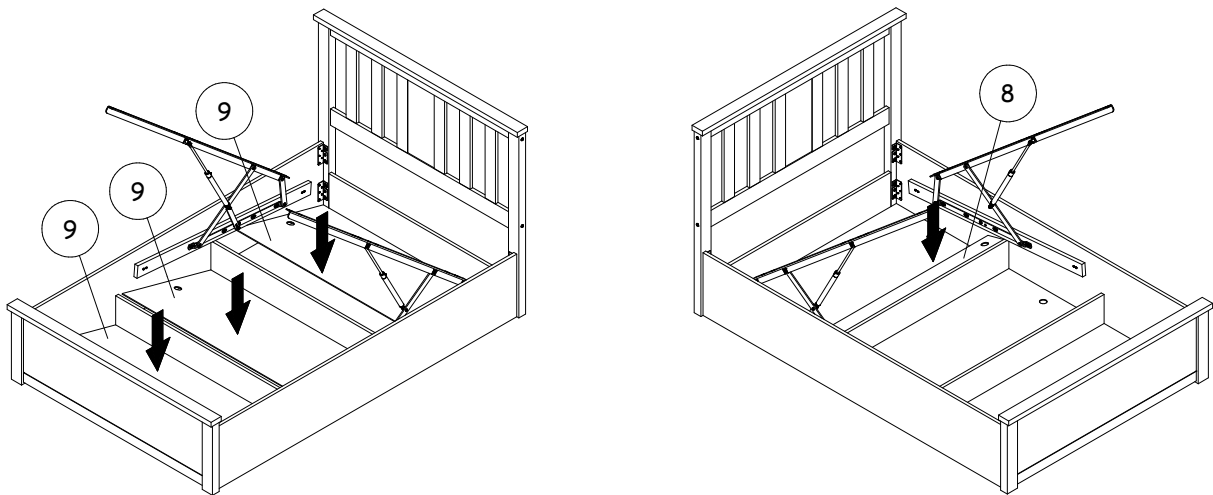

Step 9: Attach the bed base to the hydraulic frames using hardware part M. Fix the bolts starting from area 1 and finishing in area 3 – do not fully tighten the bolts yet.

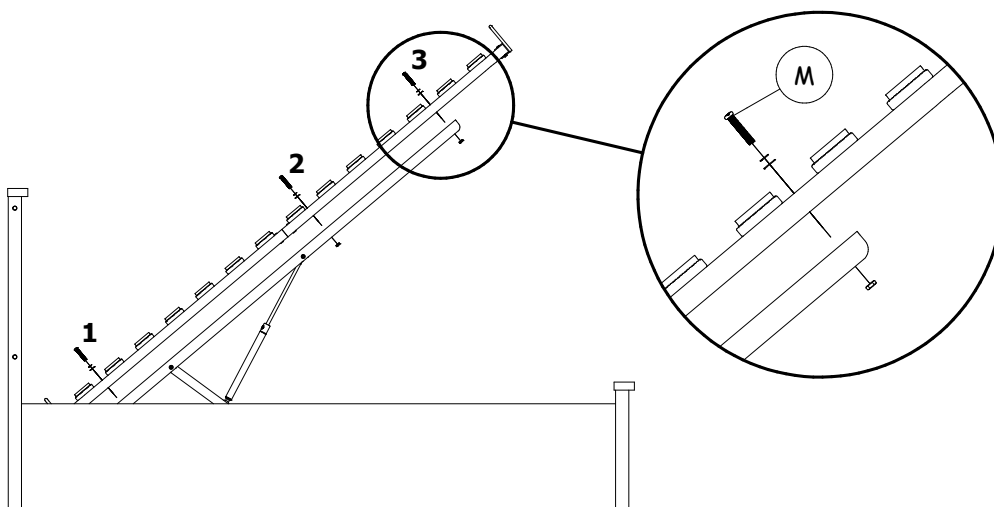

Step 10: Adjust the bed base, make sure that the distance to the footboard is approximately 15 mm to above. Tighten all bolts and screws now.

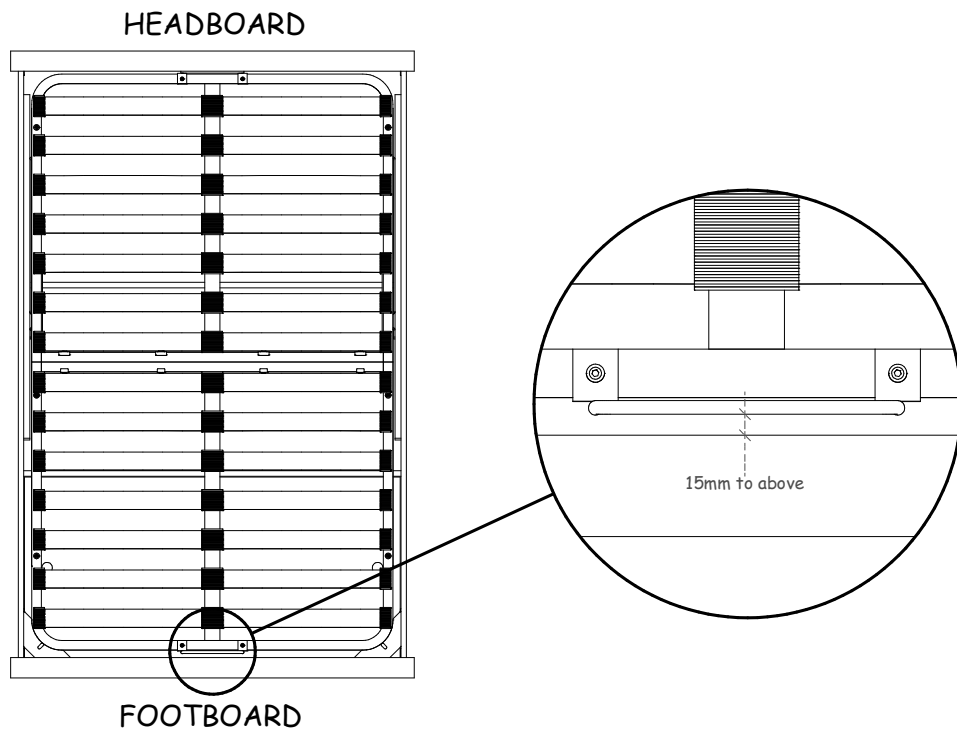

THE BED HAS BEEN FULLY ASSEMBLED

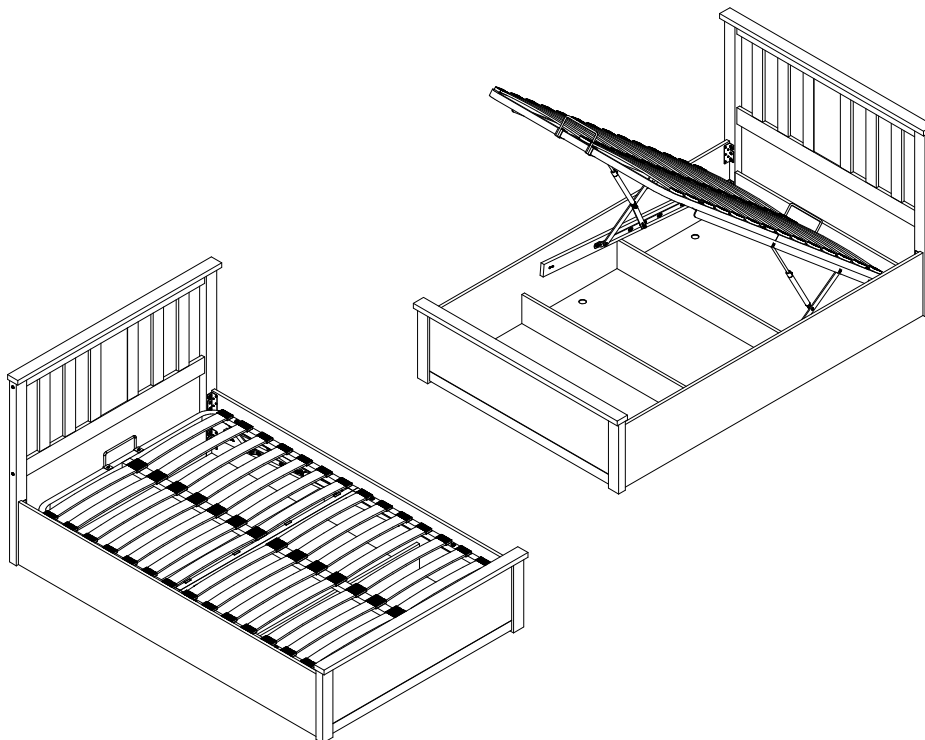

IMPORTANT NOTE

WHEN THE BED IS BUILT AND THE MATTRESS FRAME IS AT 45 A DEGREE ANGLE PLEASE PLACE THE MATTRESS ON THE BED.

PLEASE NOTE THAT THE WEIGHT OF THE MATTRESS IS REQUIRED TO HELP CLOSE THE BED.

TO LOWER THE SLEEPING PLATFORM STAND AT THE FOOT END OF THE BED AND PUSH SHARPLY DOWNWARDS USING BOTH HANDS.

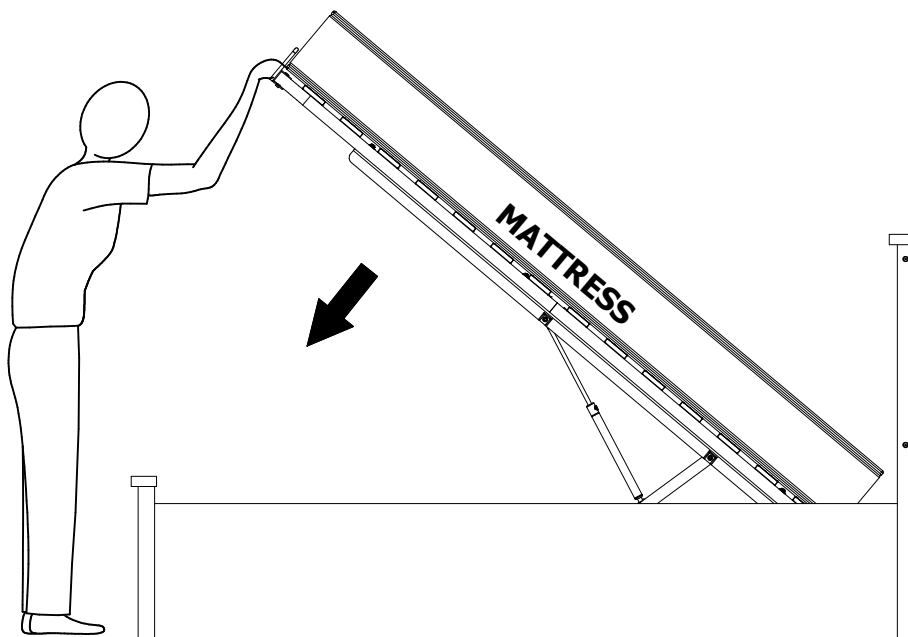

CAUTION :

PLEASE USE HYDRAULIC PUMP STOPPER FOR SAFETY PURPOSE.

